

The PILOMAT **K4/M30 SERIES** automatic bollards have been designed to ensure the anti-terrorist defence. The current models are the result of the development of more than 15 years of experience.

GENERAL FEATURES

- **hydraulic movement:** The most reliable technology for most intense use at all temperatures and weather conditions;
- **built-in hydraulic pump in the bollard:** This philosophy has many advantages, particularly in installations in locations with severe winter temperatures or when the installation requires a considerable distance (up to 80 metres) between the PILOMAT and the control unit;
- **patented system for the protection of handling:** to maximise the reliability of operations due to impact by vehicles on the cylinder that is put in motion;
- **wide range of optional configurations:** custom colours, flashing lights integrated into the head, intermittent sound signal, heat resistance installations in locations with harsh winter temperatures, UPS unit for operation in the temporary occurrence of power failure, equipment control, equipment accident prevention (see accessories and optional items).



RECOMMENDED USES

Driveways and industrial business - Research Centres - Embassies
 Police Headquarters - Military Bases - Ministerial Buildings - Sensitive Locations

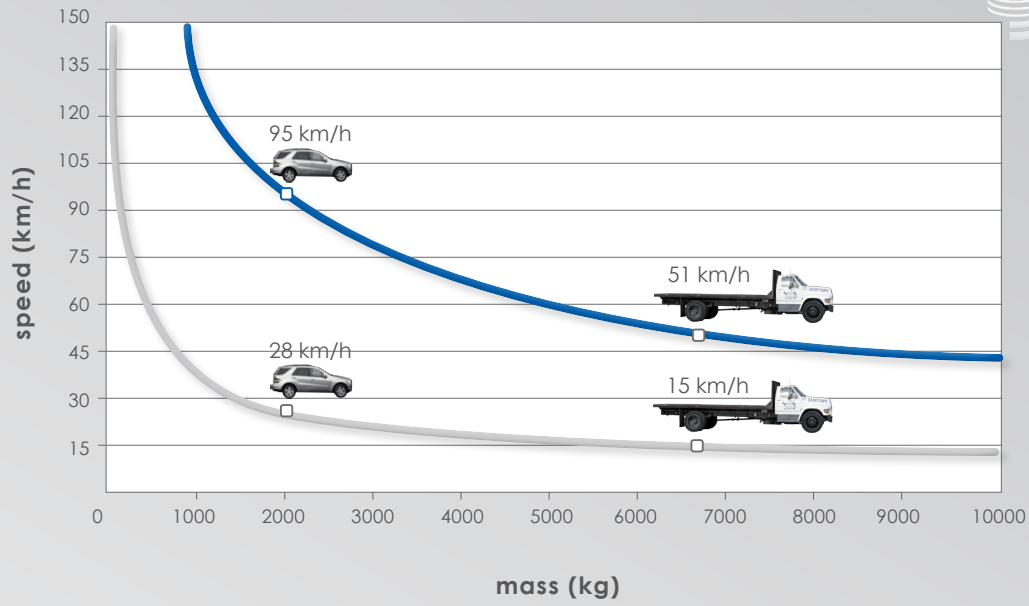
MOVING CYLINDER	FE 510 STEEL (IRON)
MOVING CYLINDER NOMINAL DIAMETER	275 mm
MOVING CYLINDER HEIGHT	900 mm
MOVING CYLINDER FE 510 STEEL THICKNESS	10 mm
MOVING CYLINDER FE 510 STEEL FINISH	POLYESTER POWDER PAINT – STANDARD GREY ANTHRACITE
OTHER MOVING CYLINDER FINISH	RIBS ON CYLINDER SURFACE - STAINLESS STEEL BRUSHED COVERING 1,5 mm
REFLECTING ADHESIVE STRIP	YES - HEIGHT 55 mm
RISING SPEED	10 cm/sec
LOWERING SPEED	20 cm/sec
MANUAL EMERGENCY LOWERING	YES (VERSION WITH RELEASE NO 220 = AUTOMATIC LOWERING)
CONNECTION LINE TO CONTROL UNIT	STANDARD 10 mt (MAXIMUM LENGTH: 80 mt)
HYDRAULIC PUMP	BUILT-IN INTO THE PILOMAT
GRADE OF PROTECTION	IP 67
TYPE OF USE	INTENSIVE - LIFE AVERAGE 2.000.000 MOVEMENTS - 2.000 MOVEMENTS/DAY
IMPACT RESISTANCE (WITHOUT DEFORMATION)	60.000 J
BREAKOUT RESISTANCE	700.000 J
OPERATING TEMPERATURE	- 40°C + 60°C (FOR LOW TEMPERATURES SEE HEATING RESISTANCE)
NOMINAL PILOMAT WEIGHT (WITHOUT PIT)	210 kg
NOMINAL WEIGHT OF STANDARD PIT, WITH COUNTER-FRAME AND BRACKETS	174 kg



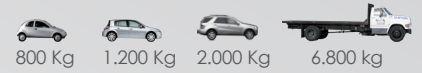



- BREAKOUT RESISTANCE **700.000 J**
- IMPACT RESISTANCE **60.000 J**

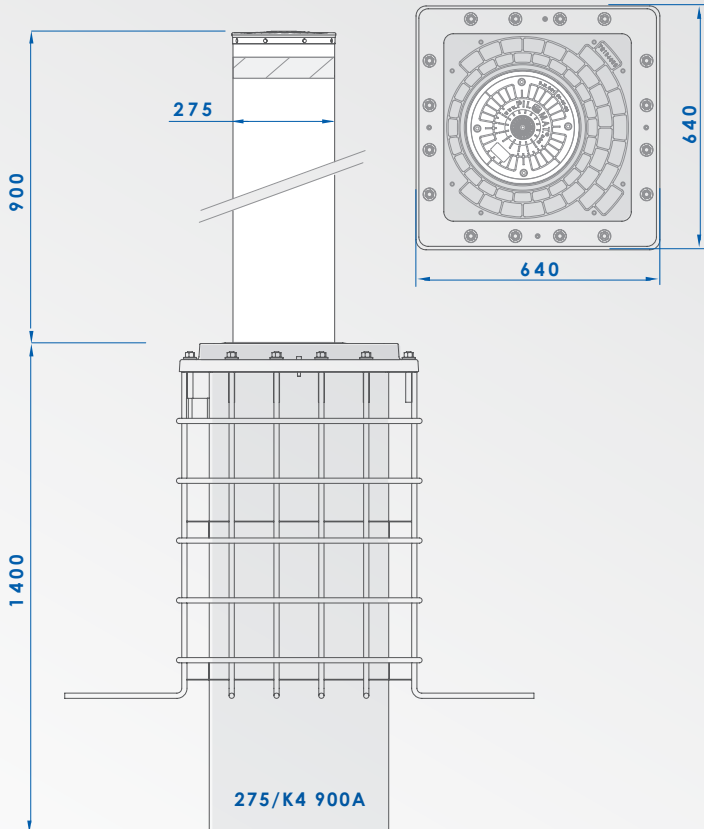

MAIN DIMENSIONS

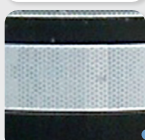

OPTIONAL ITEMS

-  INTEGRATED FLASHING LIGHT IN THE HEAD
-  RAL PAINTING ON REQUEST
-  ANONYMOUS HEAD
-  NEUTRAL REFRACTED STRIP
-  RIBS ON CYLINDERS SURFACE
- BUZZER ACOUSTIC SIGNAL DURING THE MOVEMENT
- MOVING CYLINDER STAINLESS STEEL BRUSHED COVERING
- HYDRAULIC PUMP WITH BIODEGRADABLE OIL
- CONNECTION LINE, UP TO 80 MT
- E.F.O. CIRCUIT FOR EMERGENCY LIFT, 1''
- ANTI-TAMPERING SCREW KIT FOR CROWN